



# Decorative Window Films

**ORACAL**<sup>®</sup>  
**ORAJET**<sup>®</sup>

Engineered to Perform Better™



# ORAFOL Europe GmbH

## ORAFOL's Worldwide Locations





# Index

## Decorative Window Films

Page	List of contents
4	ORAFOL® Decorative Window Films
5	ORACAL® W001 White stripes of 4mm, Interior Design
6	ORACAL® W014 White squares of 20mm, Interior Design
7	ORACAL® UV05 Frosted stripes of 35mm, Interior Design
8	ORACAL® G002 Grey stripes of 10mm, Interior Design
9	ORACAL® W002 White stripes of 10mm, Interior Decoration
10	ORACAL® W018 White Cocoon, Interior Design
11	ORACAL® W004 White stripes of 30mm, Interior Design
12	ORACAL® UV10 Frosted stripes of 5mm and 35mm, Interior Design
13	ORACAL® UV11 Frosted Squares of 44mm, Interior Design
14	ORACAL® WM20 White Matt, Interior Design
15	ORACAL® DX01 Casual White, Interior Design
16	ORACAL® DX02 White Web, Interior Design
17	ORACAL® DX03 White Dots, Interior Design
18	ORACAL® DX04 Decreasing Dots, Interior Design
19	ORACAL® DX05 Gradient Dots, Interior Design
20	ORACAL® DX06 White & Grey Diamonds, Interior Design
21	ORACAL® 8300 Transparent Cal
22	ORAJET® 3352F Optical Clear Film
22	ORAJET® 3952F Optical Clear Film
23	ORAJET® 3851 Digital Printing Film
24	ORACAL® 8510 Etched Glass Cal
24	ORACAL® 8510 RA Etched Glass Cal – with RapidAir® Technology
25	ORACAL® 8530 Etched Glass Cal
26	ORACAL® 8710 Dusted Glass Cal
27	ORACAL® 8810 Frosted Glass Cast

### ORACAL Decorative Window Films;

ORACAL Decorative Window Films offer a tremendous cost advantage in comparison to etched glasses made in traditional methods. This product range includes window films that are developed for long term use and suitable for large size graphic projects.

ORACAL Decorative Window Films can be used on acrylic plastic sheets, windows of shops, offices, lobbies, restaurants and conference rooms. ORACAL Decorative Window Films are also used on windows, glass doors and separators in laboratories and hospitals for privacy concerns.

These products provide glass design options of highest quality, without changing the glass structure or blocking sunlight.

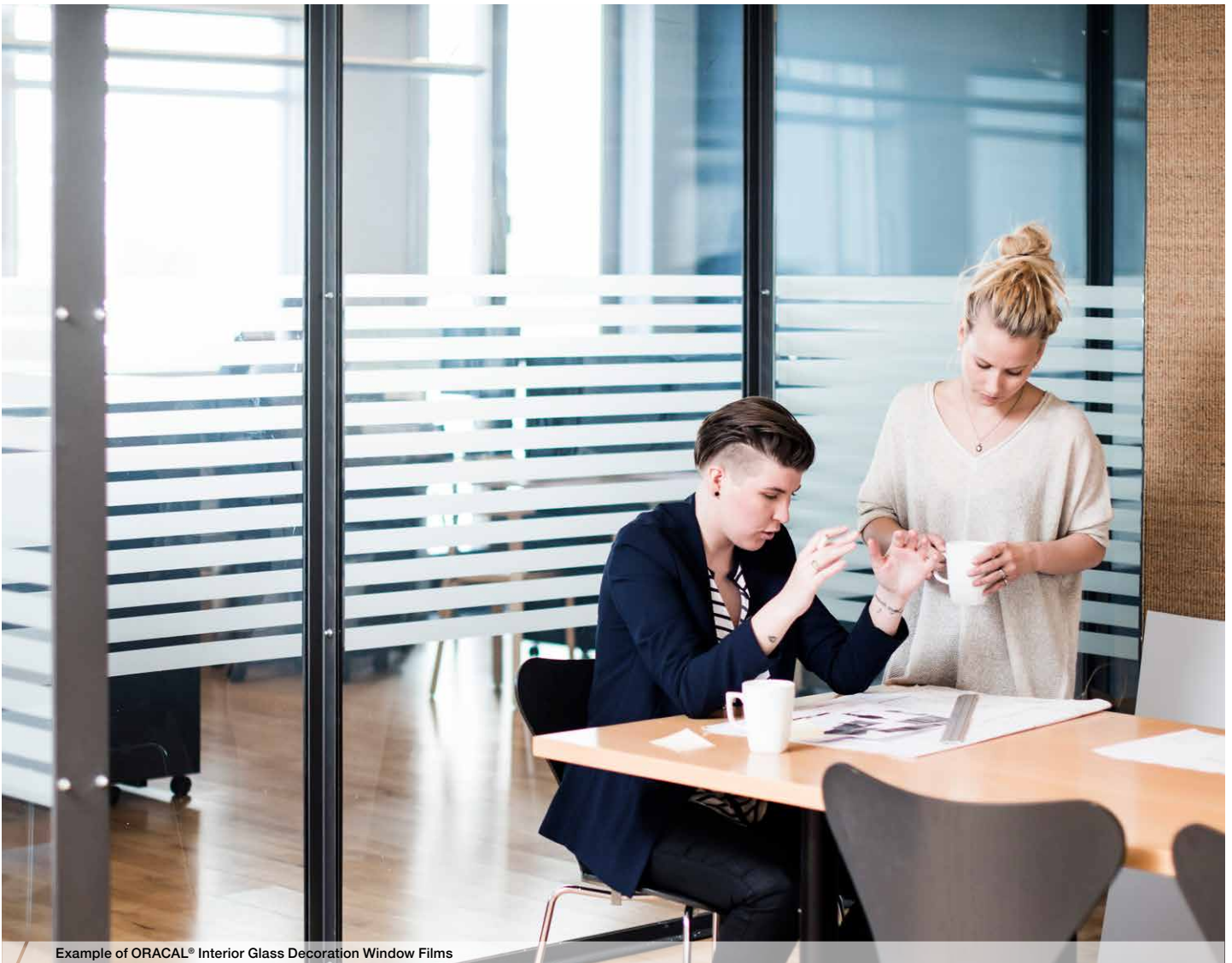

Example of ORACAL® Interior Glass Decoration Window Films

## ORACAL Interior Design Window Films: **Choose the pattern and apply!**

Provided with a ready-to-apply decorative patterns, ORACAL Interior Design Window Films offer budget friendly decorative solutions. It is now easier to create different designs!

### White stripes of 4mm, Interior Design Window Film

# ORACAL<sup>®</sup> W001

**Product Features:**

- White Stripes of 4mm
- 38 micron
- Acrylic copolymer adhesive
- Roll size: 1525mm x 30m
- Expected service life: 5 years
- Wet application is recommended.

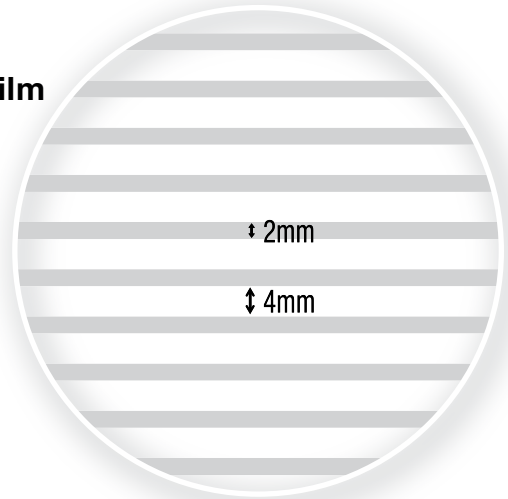

Example of ORACAL<sup>®</sup> Interior Glass Decoration Window Films

White Squares of 20mm, Interior Design Window Film

ORACAL® W014

**Product Features:**

- White Squares of 20mm
- 38 micron
- Acrylic copolymer adhesive
- Roll size: 1525mm x 30m
- Expected service life: 5 years
- Wet application is recommended.

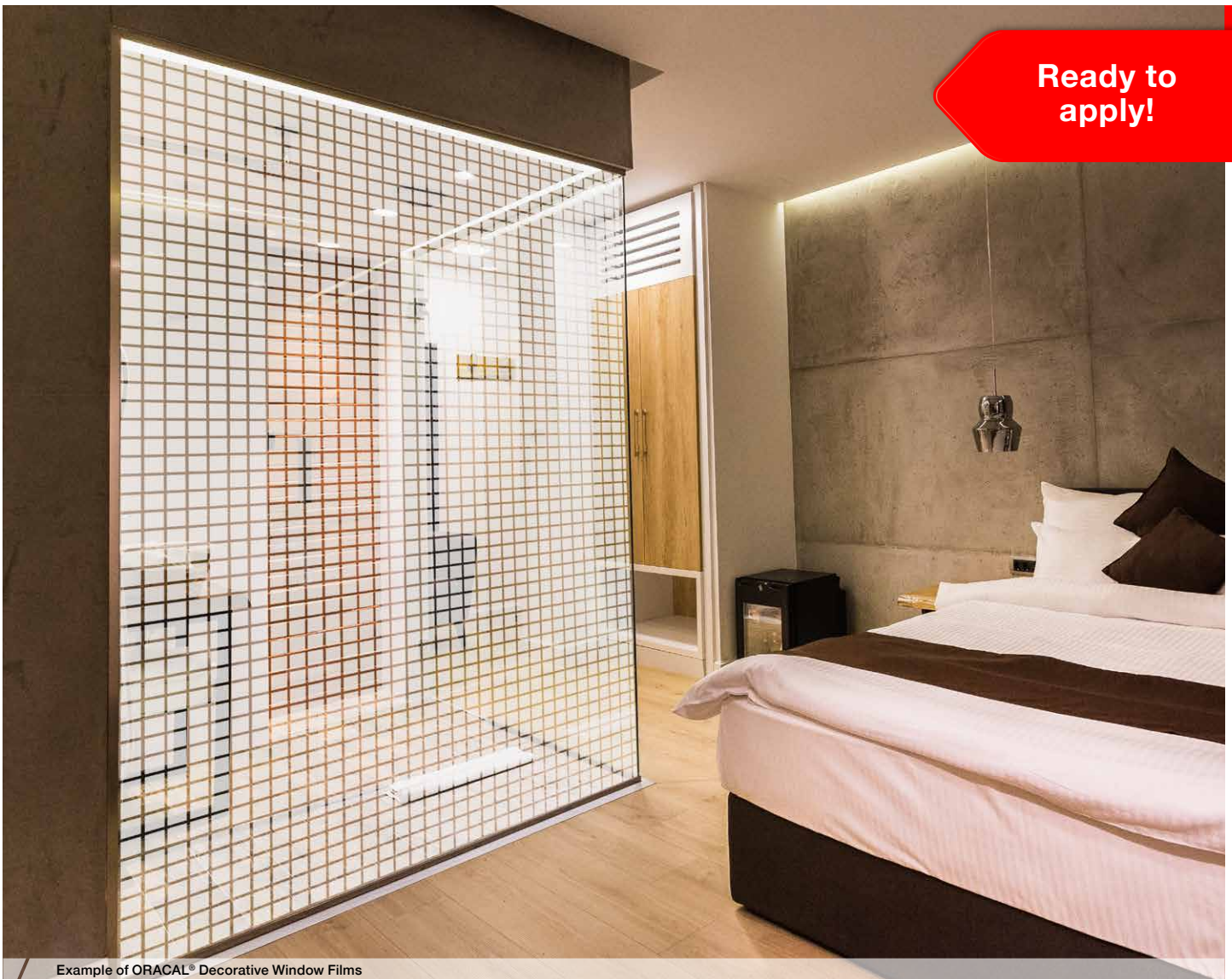
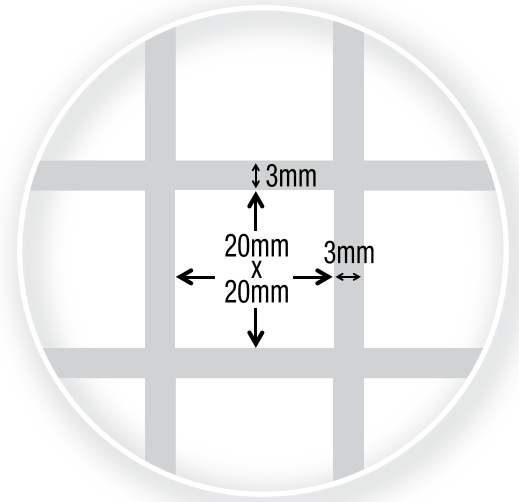

Example of ORACAL® Decorative Window Films

Frosted stripes of 35mm, Interior Design Window Film

ORACAL® UV05

**Product Features:**

- Frosted stripes of 35mm
- 38 micron
- Acrylic copolymer adhesive
- Roll size: 1525mm x 30m
- Expected service life: 5 years
- Wet application is recommended.

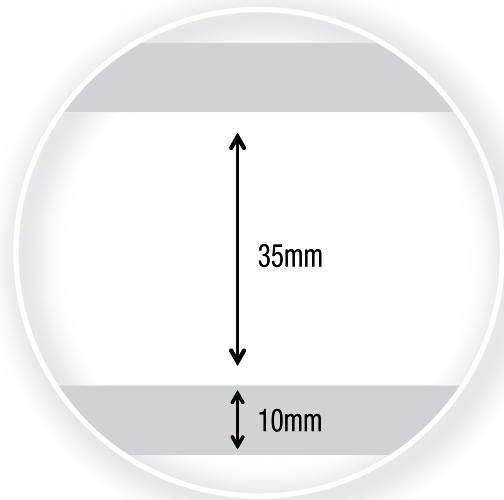

Example of ORACAL® Decorative Window Films

Grey stripes of 10mm, Interior Design Window Film

ORACAL® G002

**Product Features:**

- Grey Stripes of 10mm
- 38 micron
- Acrylic copolymer adhesive
- Roll size: 1525mm x 30m
- Expected service life: 5 years
- Wet application is recommended

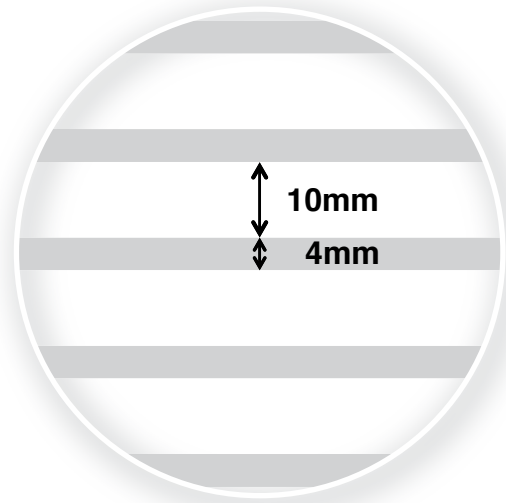

Example of ORACAL® Interior Glass Decoration Window Films



White stripes of 10mm, Interior Design Window Film

# ORACAL® W002

**Product Features:**

- White stripes of 10mm
- 38 micron
- Acrylic copolymer adhesive
- Roll size: 1525mm x 30m
- Expected service life: 5 years
- Wet application is recommended.

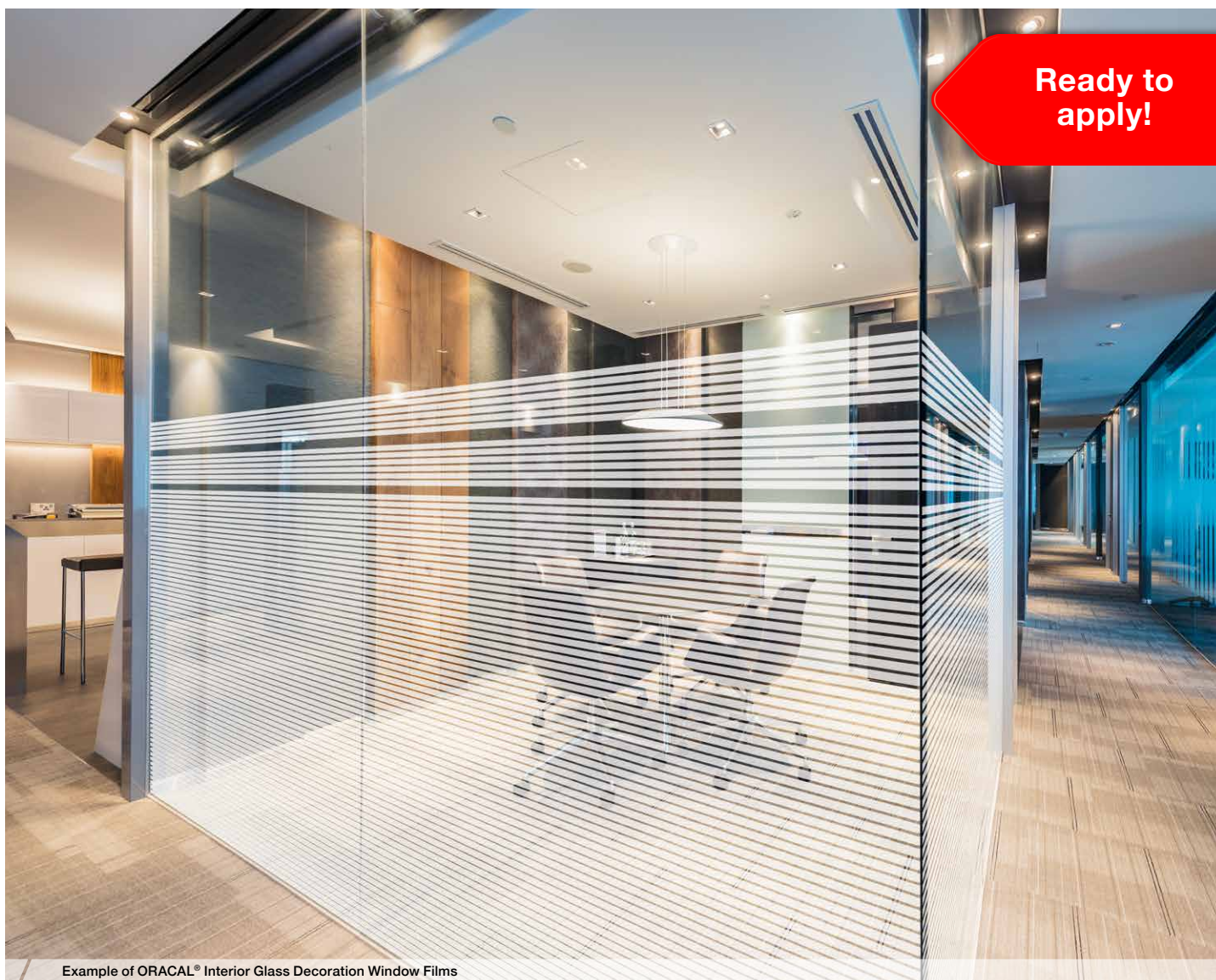
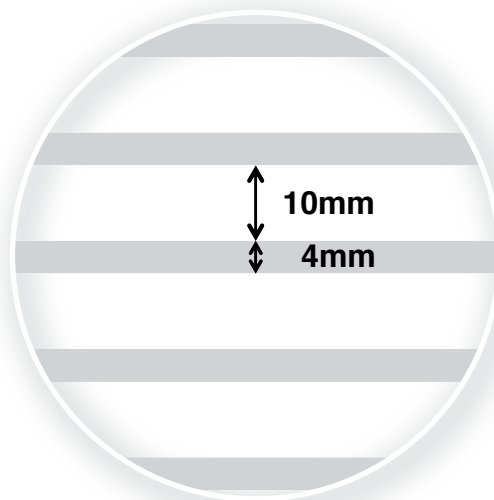

Example of ORACAL® Interior Glass Decoration Window Films

White Cocoon, Interior Design Window Film

ORACAL® W018

**Product Features:**

- White Cocoon design
- 38 micron
- Acrylic copolymer adhesive
- Roll size: 1525mm x 30m
- Expected service life: 5 years
- Wet application is recommended.

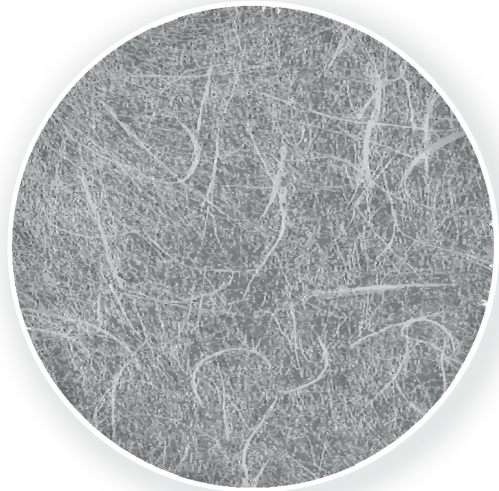

Example of ORACAL® Interior Glass Decoration Window Films

White stripes of 30mm, Interior Design Window Film

ORACAL® W004

**Product Features:**

- White stripes of 30mm
- 38 micron
- Acrylic copolymer adhesive
- Roll size: 1525mm x 30m
- Expected service life: 5 years
- Wet application is recommended.

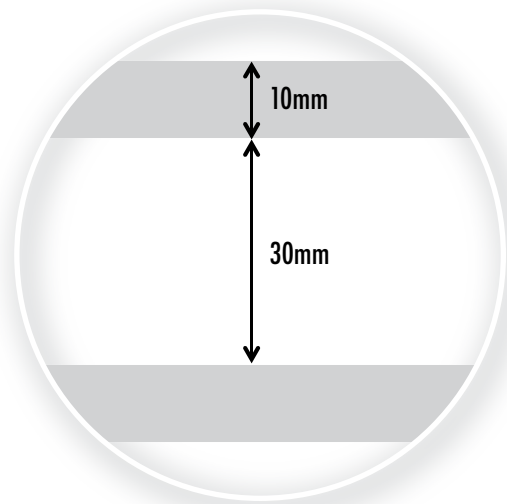

Example of ORACAL® Interior Glass Decoration Window Films

Frosted stripes of 5mm and 35mm, Interior Design Window Film

ORACAL® UV10

**Product Features:**

- Frosted stripes of 5mm and 35mm
- 38 micron
- Acrylic copolymer adhesive
- Roll size: 1525mm x 30m
- Expected service life: 5 years
- Wet application is recommended.

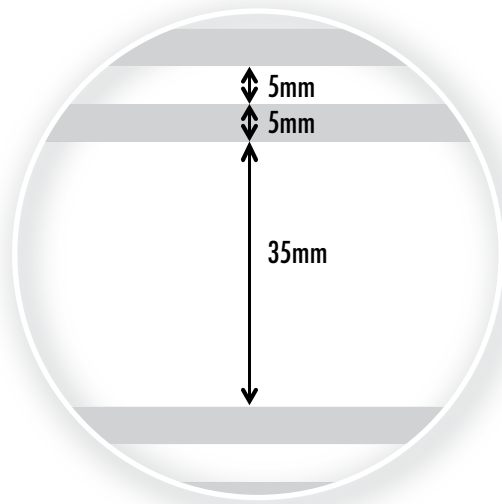

Example of ORACAL® Interior Glass Decoration Window Films

Frosted Squares of 44mm, Interior Design Window

ORACAL® UV11

**Product Features:**

- Frosted Squares of 44mm
- 38 micron
- Acrylic copolymer adhesive
- Roll size: 1525mm x 30m
- Expected service life: 5 years
- Wet application is recommended.

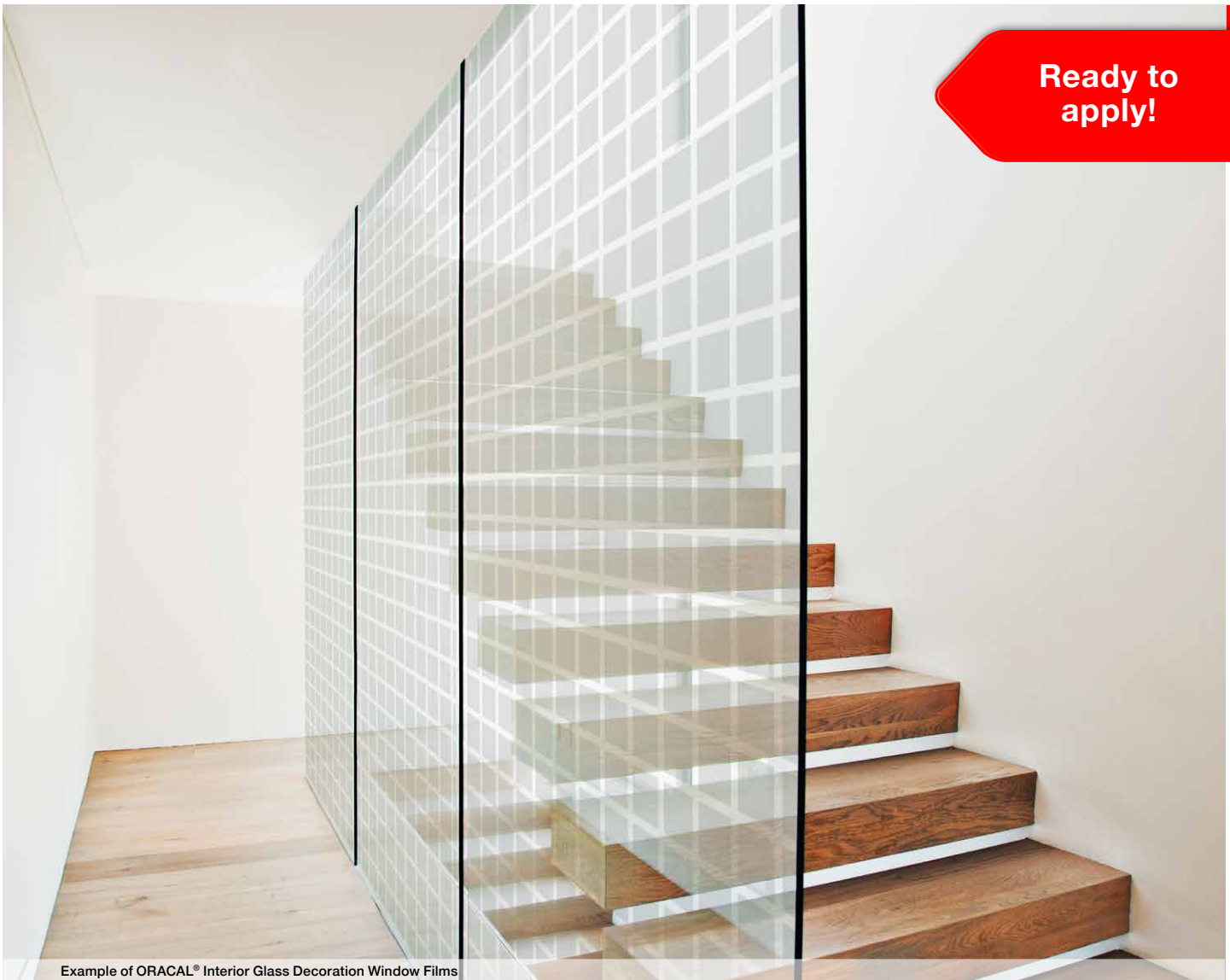
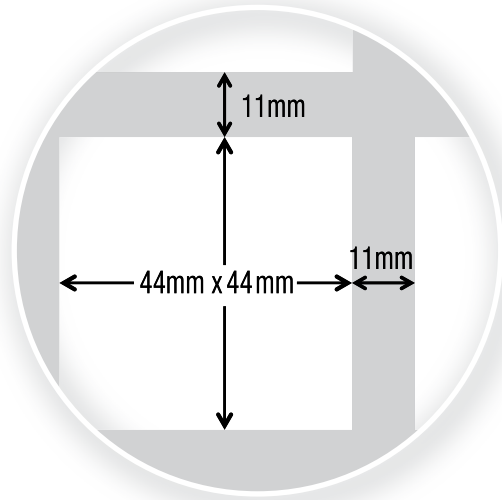

Ready to apply!

Example of ORACAL® Interior Glass Decoration Window Films

**White Matt, Interior Design Window Film**

**ORACAL® WM20**

**Product Features:**

- White Matt
- 38 micron
- Acrylic copolymer adhesive
- Roll size: 1525mm x 30m
- Expected service life: 5 years
- Wet application is recommended.



Example of ORACAL® Interior Glass Decoration Window Films

**NEW!**

Casual White, Interior Design Window Film

ORACAL® DX01

**Product Features:**

- Vertical white lines
- 50 micron
- Acrylic copolymer adhesive
- Roll size: 1270mm x 30m
- Expected service life: 5 years
- Wet application is recommended

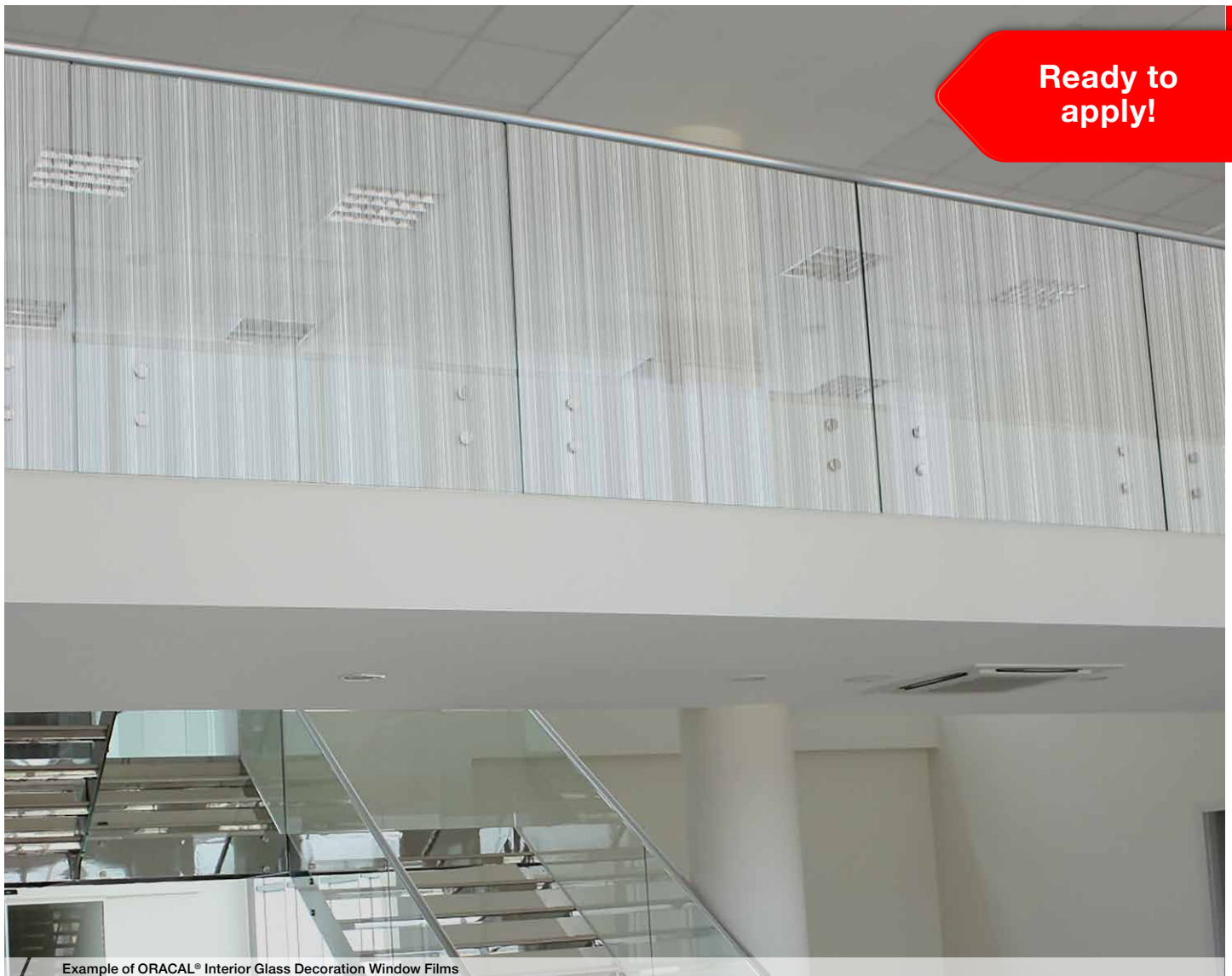
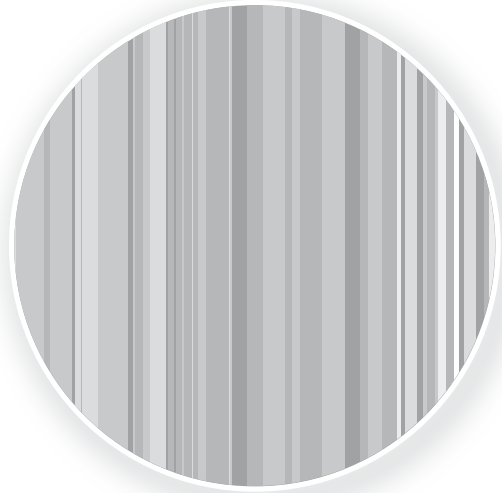

Example of ORACAL® Interior Glass Decoration Window Films

**NEW!**

White Web, Interior Design Window Film

ORACAL® DX02

**Product Features:**

- White Grids
- 50 micron
- Acrylic copolymer adhesive
- Roll size: 1270mm x 30m
- Expected service life: 5 years
- Wet application is recommended

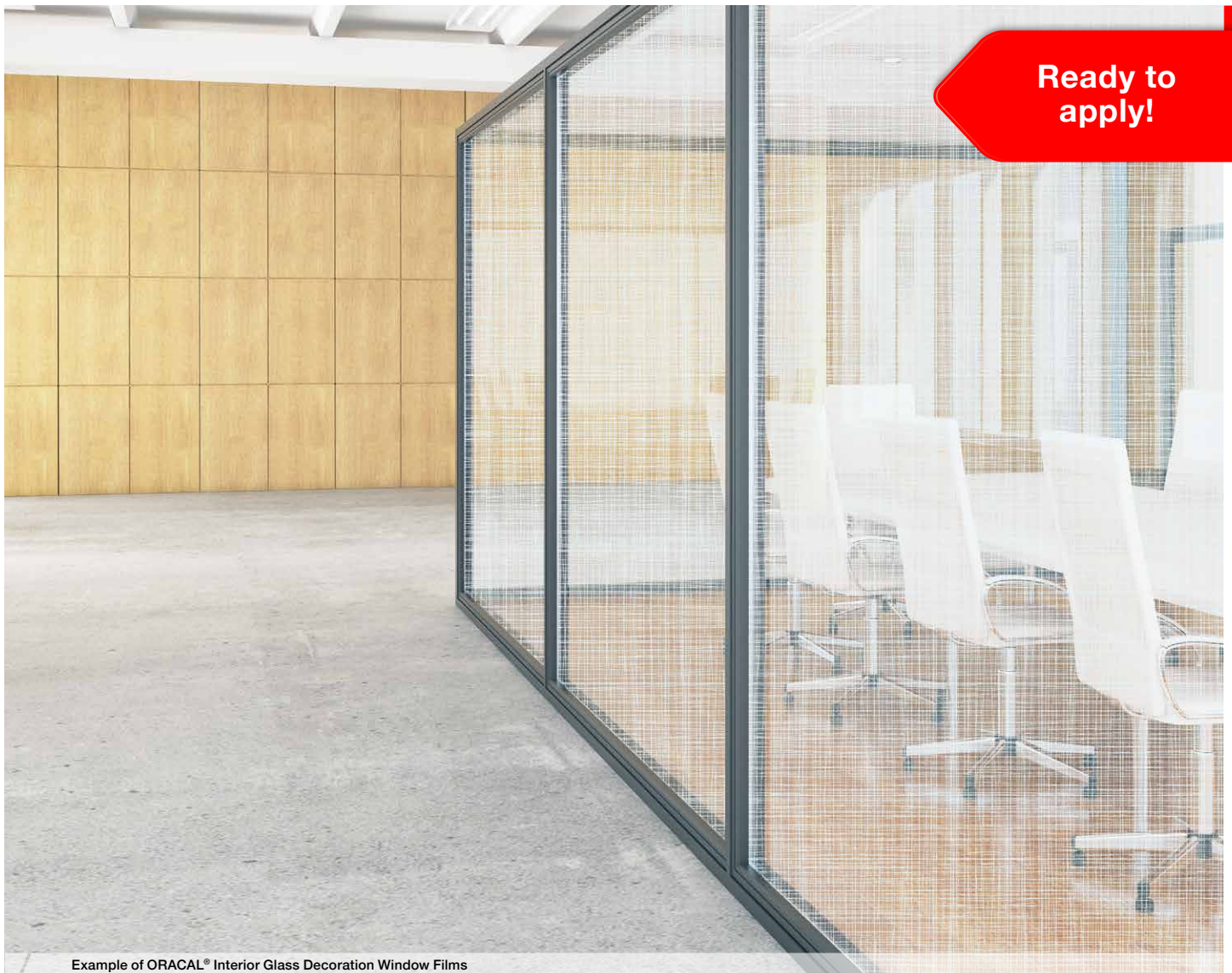

Example of ORACAL® Interior Glass Decoration Window Films



**NEW!**

White Dots, Interior Design Window Film

ORACAL® DX03

**Product Features:**

- White circles of 3mm diameter
- 50 micron
- Acrylic copolymer adhesive
- Roll size: 1270mm x 30m
- Expected service life: 5 years
- Wet application is recommended

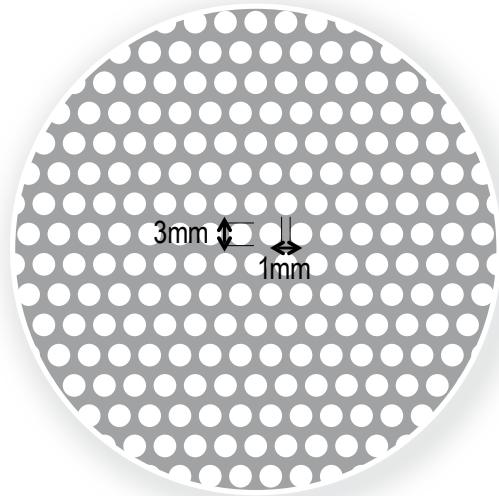

Example of ORACAL® Interior Glass Decoration Window Films

**NEW!**

**Decreasing Dots, Interior Design Window Film**

ORACAL® DX04

**Product Features:**

- Gradient design with white circles
- 50 micron
- Acrylic copolymer adhesive
- Roll size: 1270mm x 30m
- Expected service life: 5 years
- Wet application is recommended

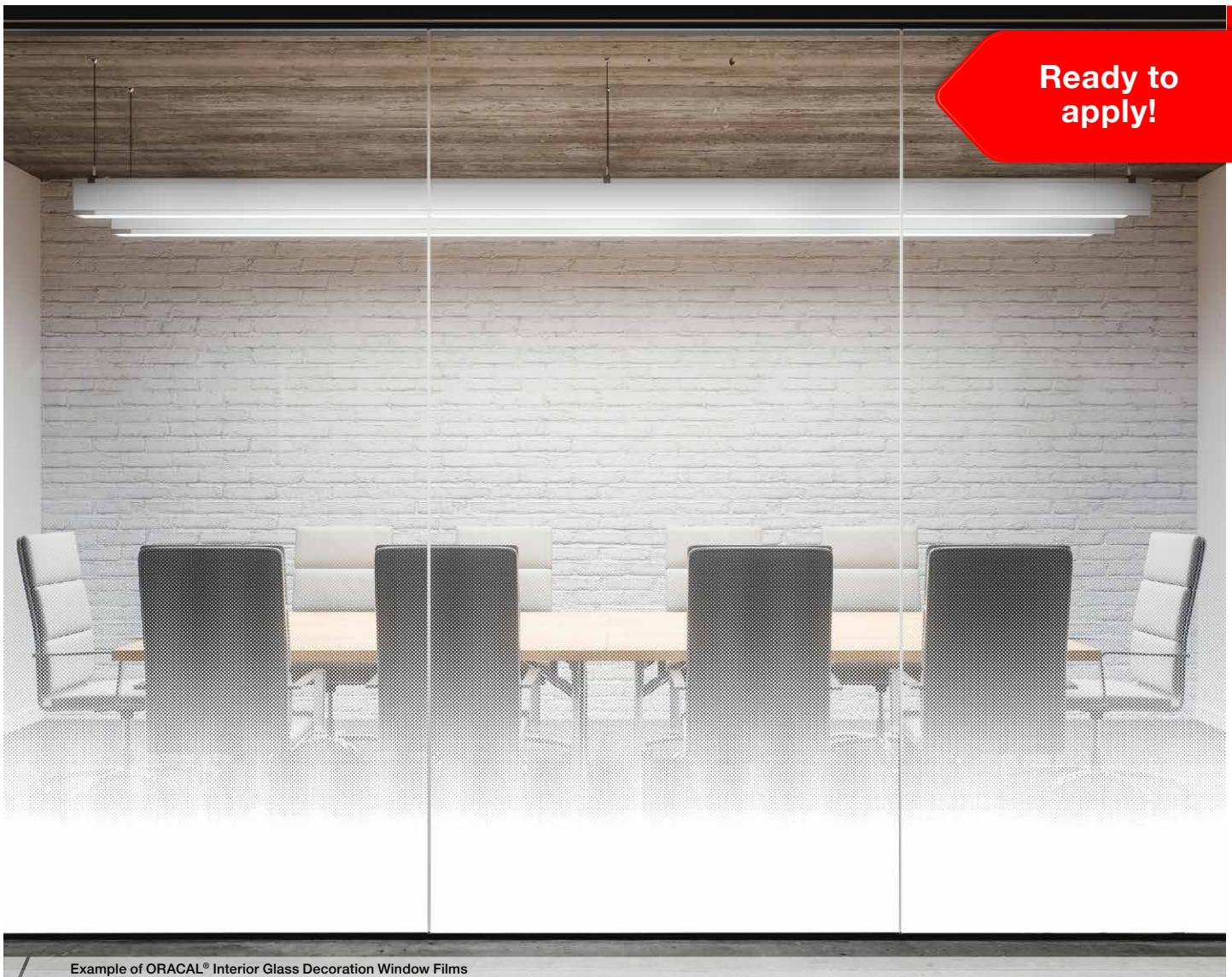
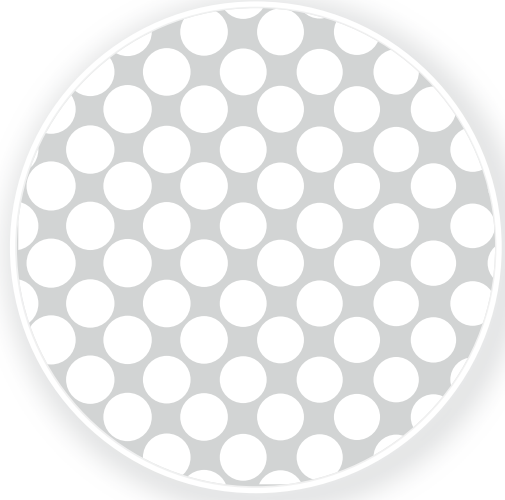

Example of ORACAL® Interior Glass Decoration Window Films

**NEW!**

**Gradient Dots, Interior Design Window Film**

ORACAL® DX05

**Product Features:**

- Gradient design with vertical lines of white dots
- 50 micron
- Acrylic copolymer adhesive
- Roll size: 1270mm x 30m
- Expected service life: 5 years
- Wet application is recommended

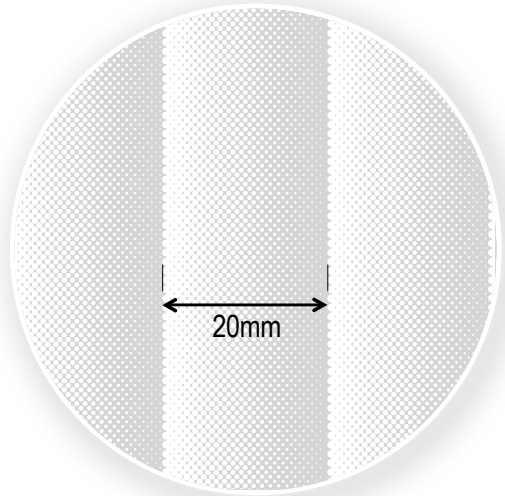

**Ready to apply!**

Example of ORACAL® Interior Glass Decoration Window Films

**NEW!**

White & Grey Diamonds, Interior Design Window Fil

ORACAL® DX06

**Product Features:**

- White & grey quadrilaterals with diamond appearance
- 50 micron
- Acrylic copolymer adhesive
- Roll size: 1270mm x 30m
- Expected service life: 5 years
- Wet application is recommended

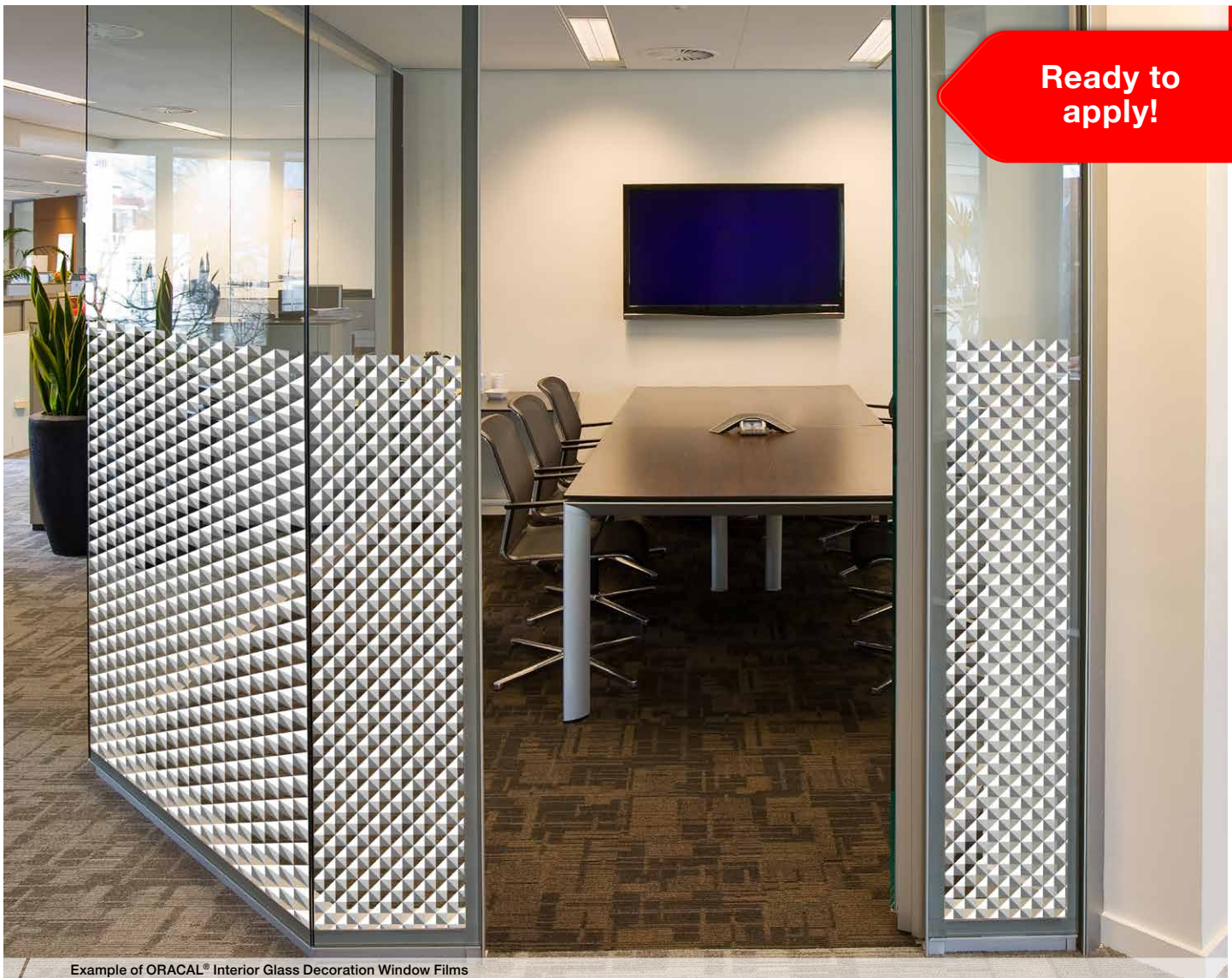
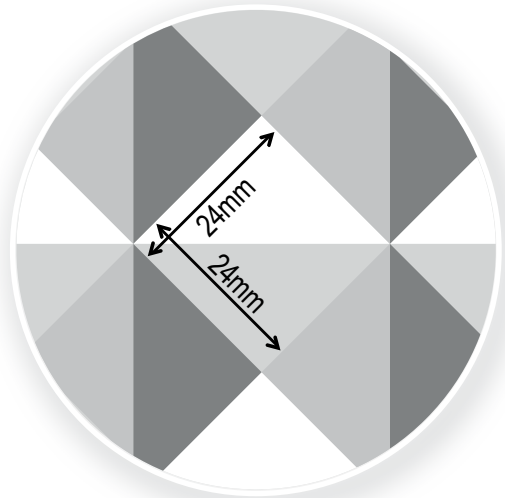

Example of ORACAL® Interior Glass Decoration Window Films

### Transparent Cal

# ORACAL<sup>®</sup> 8300

Transparent film in 32 attractive colours for indoor and outdoor decorative design use on glass and plexiglass, especially for window graphics.

#### Product benefits include:

- Transparent PVC film (80 micron) with UV stabilisers
- 32 glossy colours
- Solvent polyacrylate, permanent, transparent
- Expected service life: 5 years
- Dry and wet application



Example of ORACAL<sup>®</sup> 8300 Transparent Cal / Photo: Courtesy of Ryerson, USA

**Optical Clear Film**

# ORAJET® 3352F

With the new digital printing film ORAJET® 3352F Optical Clear Film from ORAFOL, installation of glass decorations has never been easier. This optically clear film can be digitally printed, and the printed designs are then installed in full sheets making installation faster and easier than ever. In the areas on the film where there is no print, the ORAJET® 3352F film is so clear that it is hard to even notice the film. The film is suitable for indoor and short-term outdoor application and is easily removable.

**Product benefits include:**

- Ultra transparent top-coated polyester film (70 micron)
- Available with a glossy surface
- For indoor and short-term outdoor application on windows
- Wet installation possible
- Inkjet printing with solvent based inks, UV- or Latex inks
- Solvent polyacrylate, removable

# ORAJET® 3952F

The new ORAJET® 3952F enables easy installation of window graphics. The long term durability of 7 years (not printed) makes it the perfect choice for many window applications. The printed window graphics can be installed in full sheets, making installation faster and easier than ever. In the areas on the film where there is no print, the ORAJET® 3952F is so clear that it is hard to even notice the film. The material is printable with solvent based inks, UV or Latex inks.

**Product benefits include:**

- Ultra clear, glossy Premium Cast PVC film (50 micron)
- Used for ultra clear colourful advertising and glass decorations, for indoor and long-term outdoor application on windows.
- Recommended: wet application.
- Inkjet printing with solvent based inks, UV- or latex inks
- ORAGUARD® 252F is recommended in combination with 3952F
- Solvent polyacrylate, semi-permanent



Example of ORAJET® 3352F / ORAJET® 3952F

### Digital Printing Film

# ORAJET® 3851

Digitally printable film for glass decoration

Whether for artistic effect or simply to create privacy, the new ORAJET® 3851 is the perfect modern alternative to traditional etched glass, with its ability to be also digitally printed. The prints will look outstanding with a subtle shimmery look coming from the vinyl. With its long term durability (7 years), it is an ideal choice for applications onto shop windows and glass doors.

The material is printable with solvent based inks or UV inks.

#### Product benefits include:

- Special PVC film (80 micron)
- Silver grey (fine structure)
- Ideal for indoor and long-term outdoor glass applications
- Wet application is recommended
- Suitable for inkjet printing with solvent and UV inks.
- Solvent polyacrylate, difficult to disassemble
- Expected service life: 7 years (not printed)

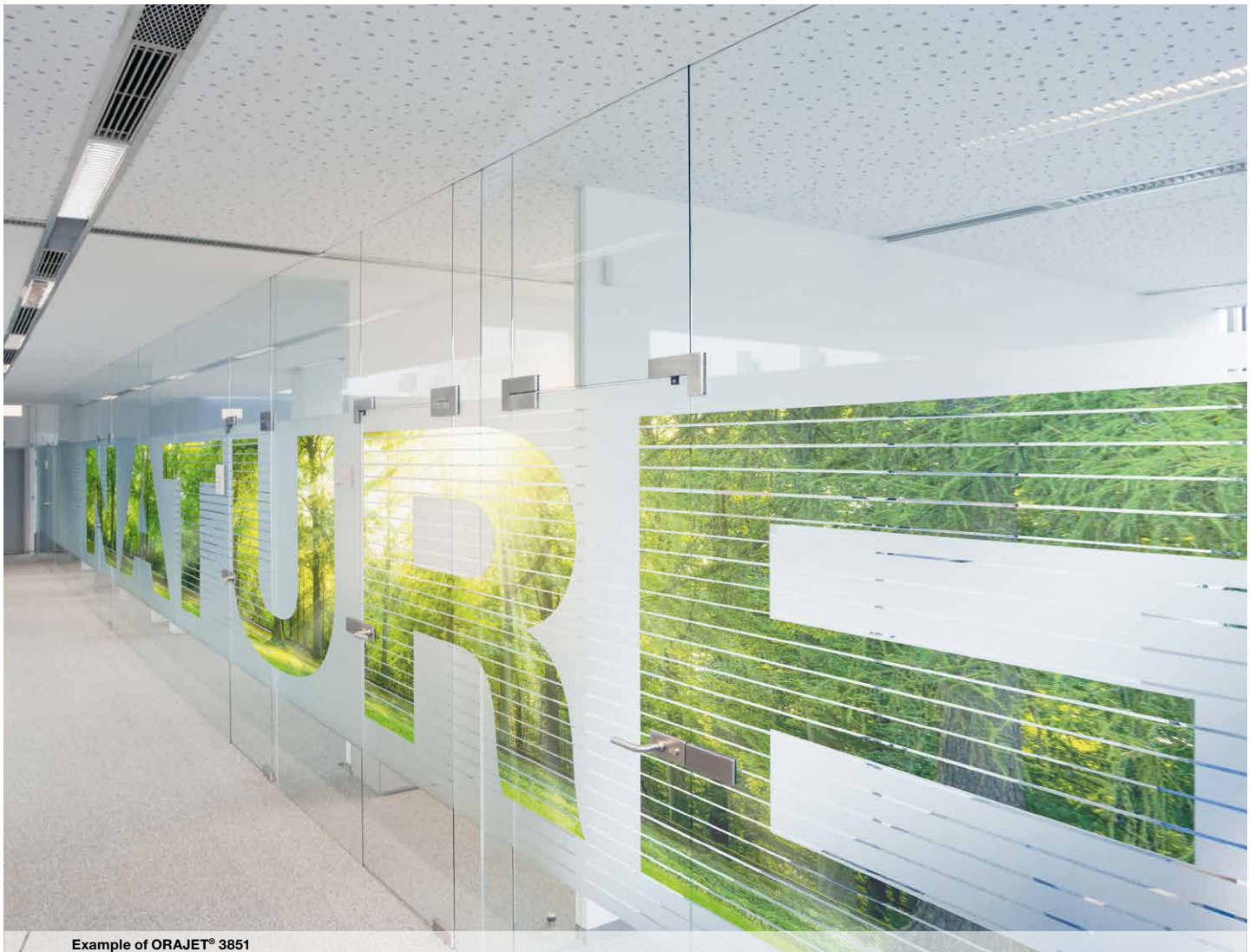

Example of ORAJET® 3851

## Etched Glass Cal

# ORACAL® 8510

Used for decorative design of shop windows and glass doors. Available in gold and silver-grey with hoarfrost effect, or an impression of etched, cut or sandblasted glass.

### Product benefits include:

- Polymer PVC film (80 micron)
- Coarse and fine structure
- Wet application is recommended
- Solvent polyacrylate, permanent, transparent
- Expected service life: 7 years

## Etched Glass Cal – with *RapidAir*® Technology

# ORACAL® 8510RA



### RA product benefits also include:

- The *RapidAir*® technology allows a rapid and bubble-free application
- *RapidAir*® requires less application time and cost

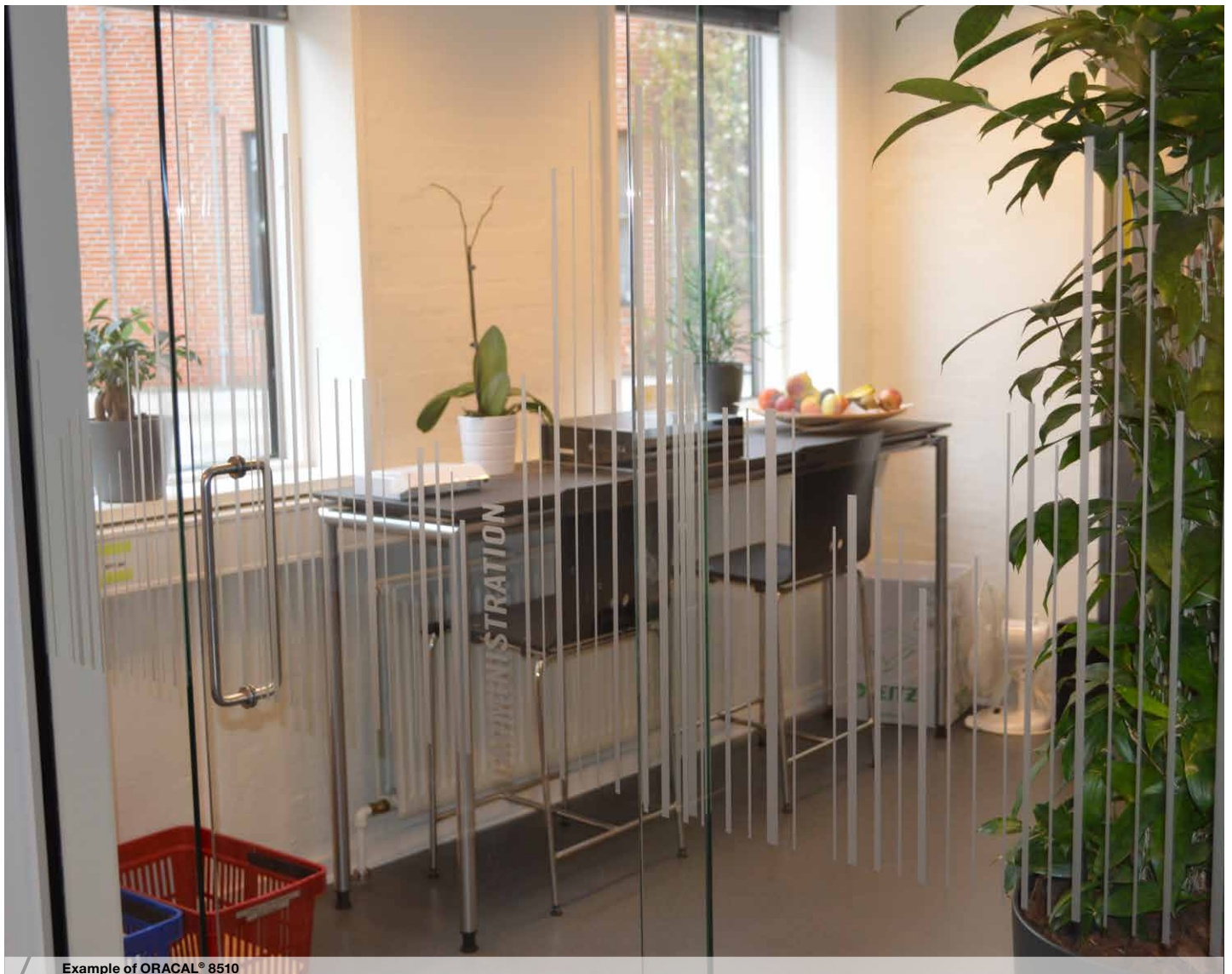

Example of ORACAL® 8510



### Etched Glass Cal

# ORACAL® 8530

Exceptionally easy to remove

**Product benefits include:**

- Polymer PVC film (80 micron)
- **Exceptionally easy to remove**
- In silver with hoarfrost effect, or an impression of etched, cut or sandblasted glass (coarse and fine structure)
- For the decorative design of shop windows and glass doors
- Solvent polyacrylate, removable
- Expected service life: 5 years



Example of ORACAL® 8530

### Dusted Glass Cal

# ORACAL® 8710

Even more possibilities for decorative designs of glass areas, such as shop windows, room dividers and glass doors.

Creates the look of a rough glass surface.



#### Product benefits include:

- Polymer PVC film (70 micron)
- Medium glossy surface prevents unwanted light reflections
- Wet application is recommended
- Solvent polyacrylate, permanent, transparent
- Expected service life: 7 years



Example of ORACAL® 8710

## Frosted Glass Cast

# ORACAL® 8810

For extra high quality glass decoration of shop windows and glass doors. Five variants available with hoarfrost effect.



### Product benefits include:

- Cast high-performance PVC film (80 micron)
- Eye-catching, glamorous glitter effects
- Extreme resistance to weathering and UV
- Wet application is recommended
- Solvent polyacrylate, permanent, transparent
- Expected service life: 7 years

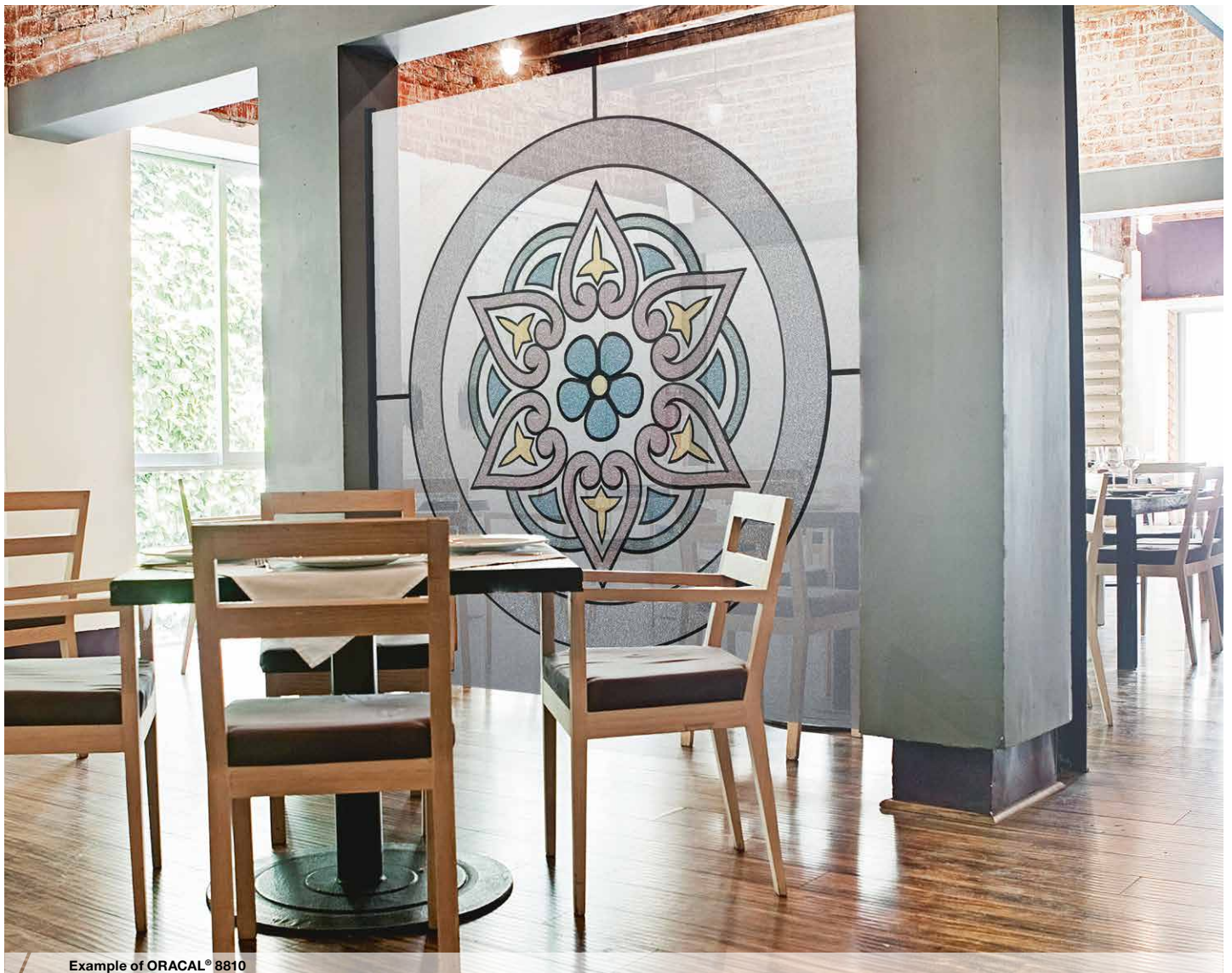

Example of ORACAL® 8810

Decorative Window Films  
**Engineered to Perform Better™**



[www.orafol.com.tr](http://www.orafol.com.tr)